

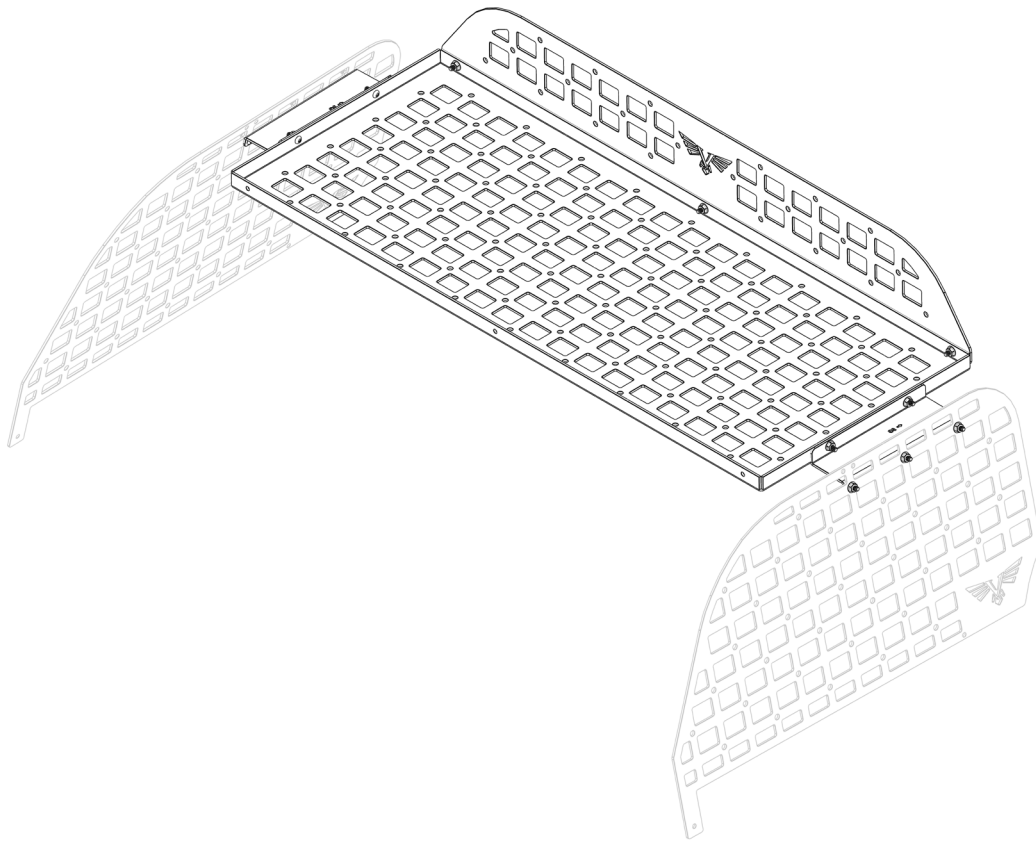

VICTORY 4X4

# 5TH GEN 4RUNNER UPPER SHELF

## INSTALL INSTRUCTIONS



**Please read the mounting instructions below carefully before attempting to install.**

**Be sure to check out the install video on the product page, if available.**

Thank you for purchasing from Victory 4x4! Checkout our website, [victory4x4.com](http://victory4x4.com) for other great off-road products. Be sure to rate and review our product online. If you have any questions or are missing parts, please don't hesitate to call us at 269-459-8447!

# INCLUDED HARDWARE

13x

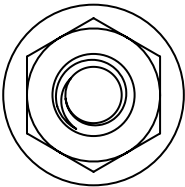

1/4"-20  
Serr. Flange Nut

13x



1/4"-20 X 3/4"  
Button Head

# INCLUDED PARTS

1x

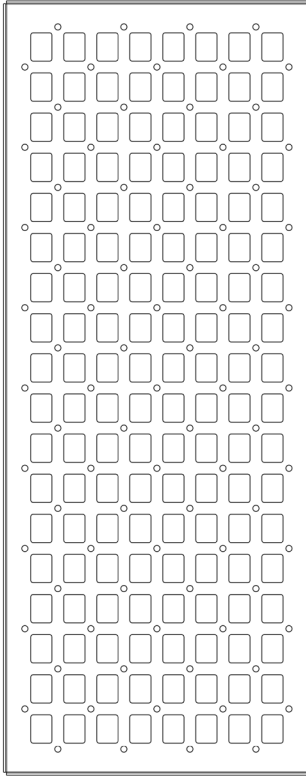

1x

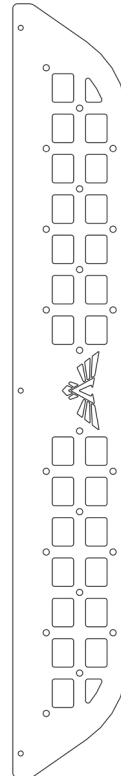

1L/1R

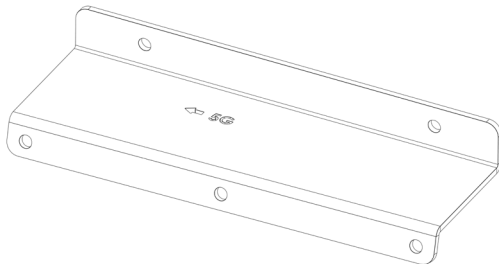

# INSTALLATION

- 1** Start by installing the mounts onto the Rear Window MOLLE Panels. Do this using three 1/4"-20 X 3/4" button head bolts and three 1/4"-20 serr. flange nuts per mount. Mount them to the top row of holes on the panels, using all holes except for the one closest to the hatch of the vehicle.

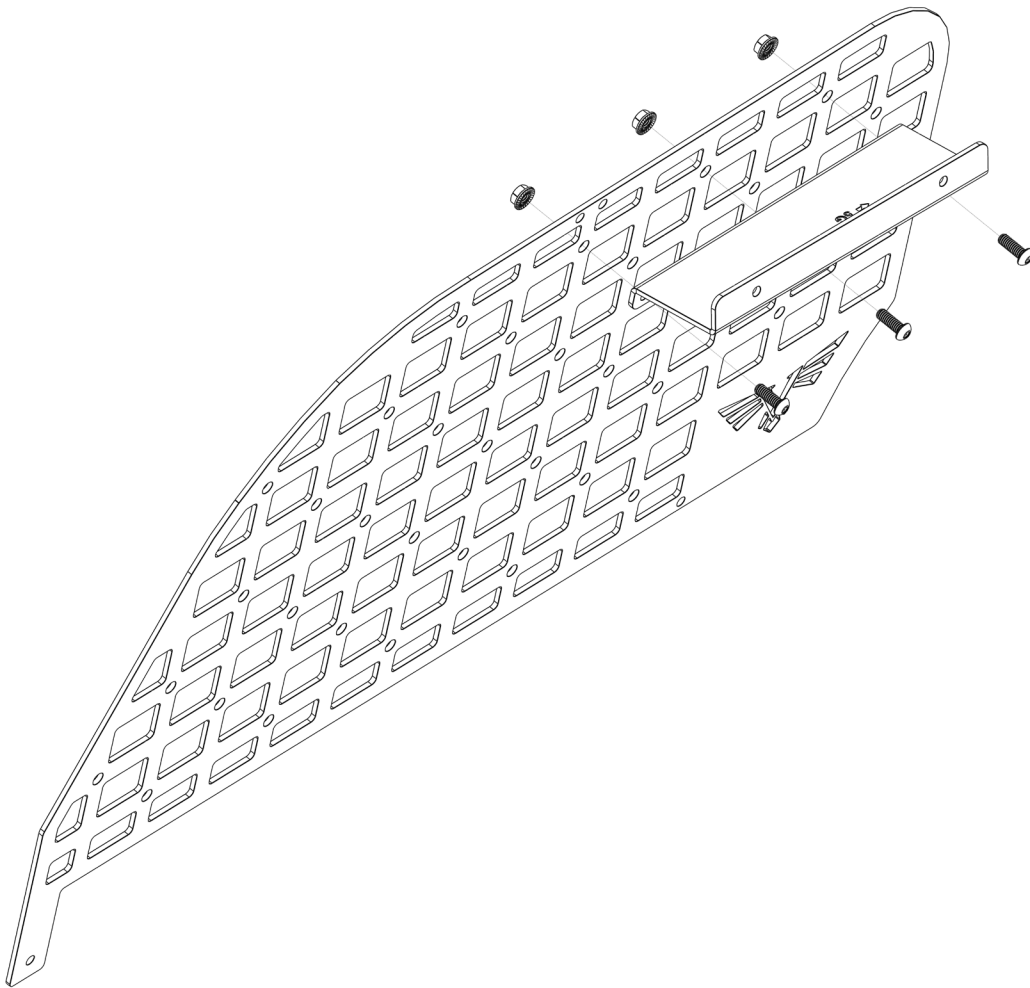

# INSTALLATION

- 2 Next, Attach the front panel to the basket using three 1/4"-20 X 3/4" button head bolts and three 1/4"-20 serr. flange nuts.

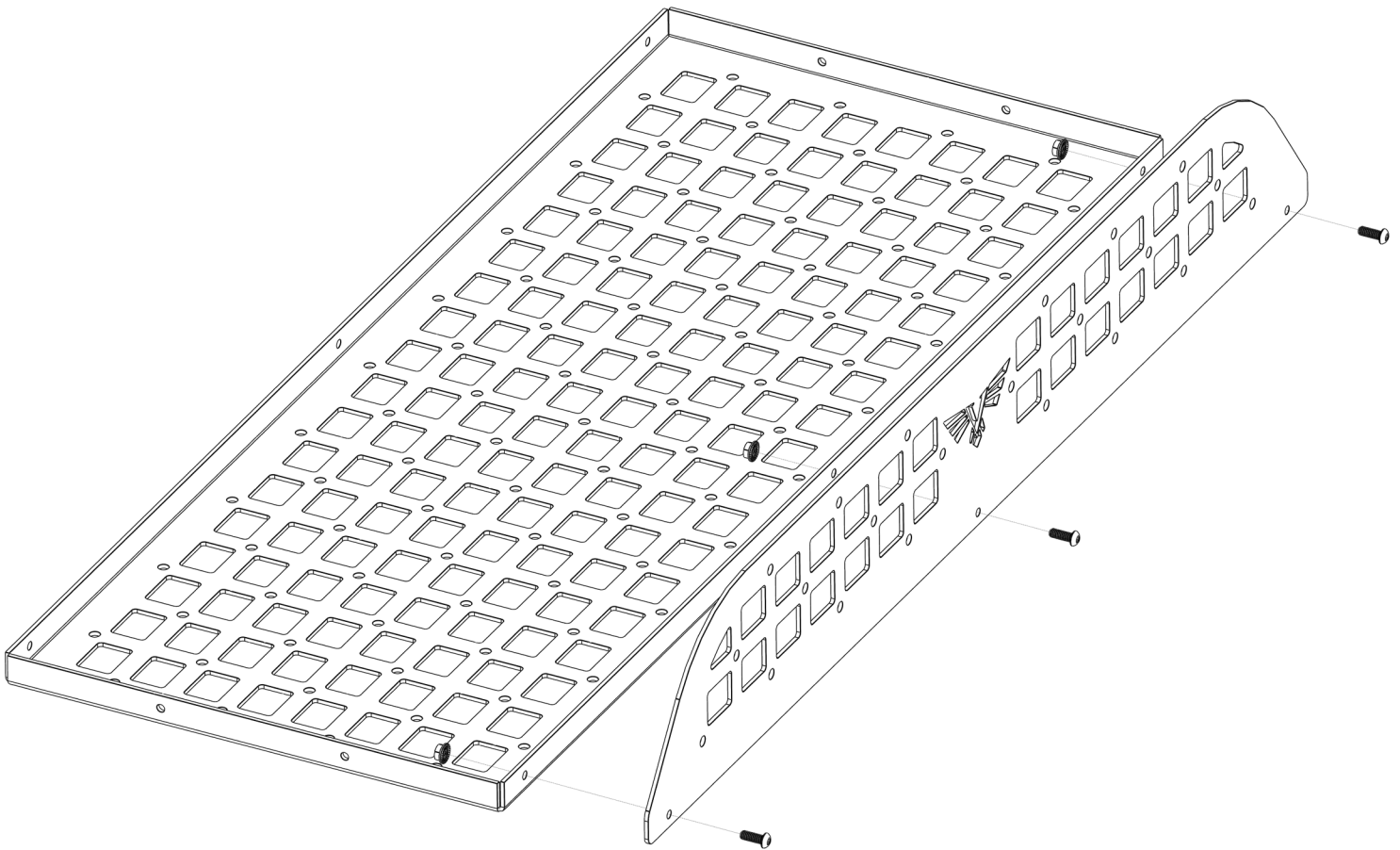

# INSTALLATION

- 3 Finally, raise the basket up between the two mounts and attach them together using two 1/4"-20 X 3/4" button head bolts and two 1/4"-20 serr. flange nuts per side.

