

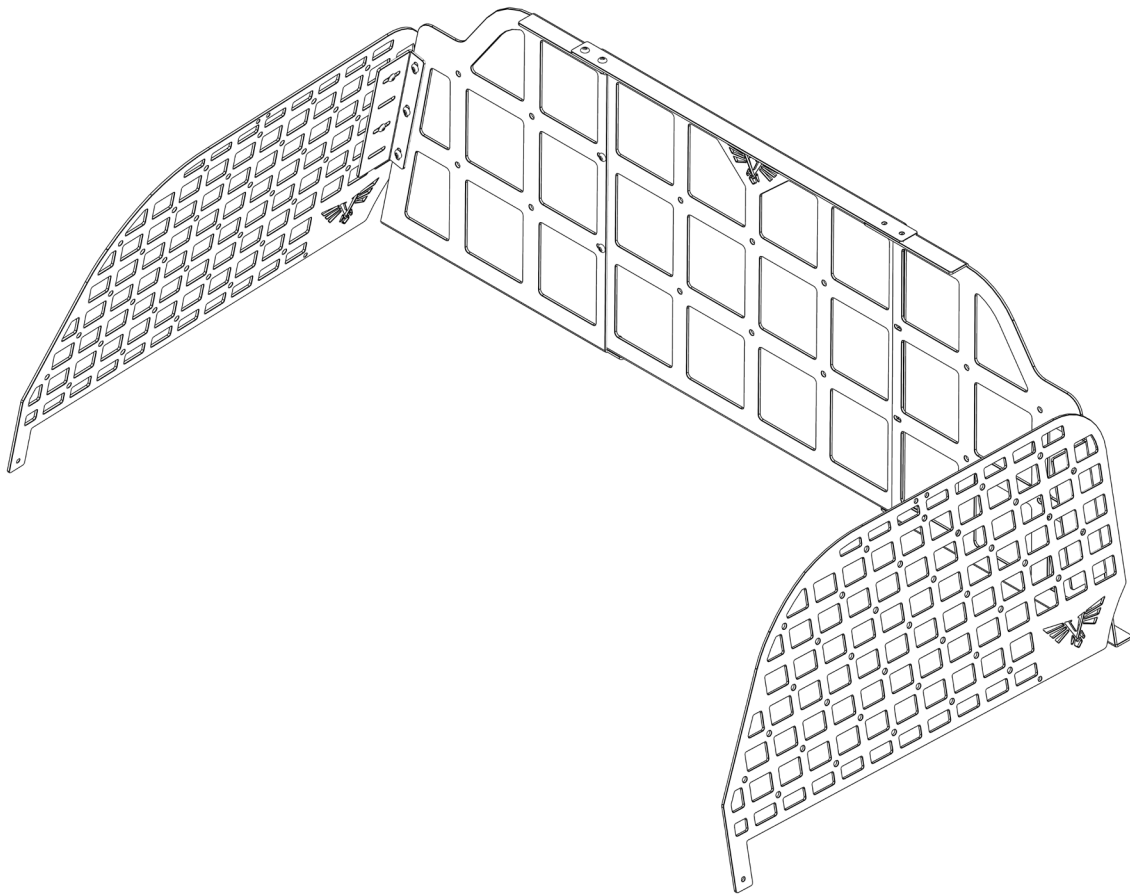

VICTORY 4X4

5TH GEN 4RUNNER PET DIVIDER

INSTALL INSTRUCTIONS



Please read the mounting instructions below carefully before attempting to install.

Be sure to check out the install video on the product page, if available.

Thank you for purchasing from Victory 4x4! Checkout our website, victory4x4.com for other great off-road products. Be sure to rate and review our product online. If you have any questions or are missing parts, please don't hesitate to call us at 269-459-8447!

INCLUDED HARDWARE

22x

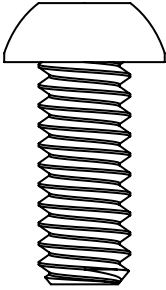

1/4"-20 3/4"
Button Head

22x

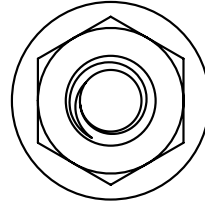

1/4"-20
Serr. Flange Nut

INCLUDED PARTS

2x

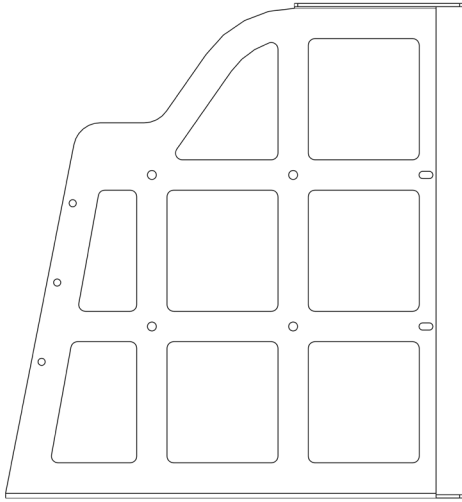

2x

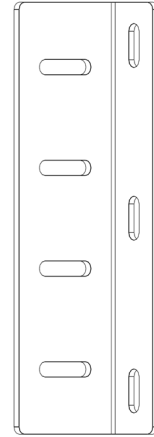

1x

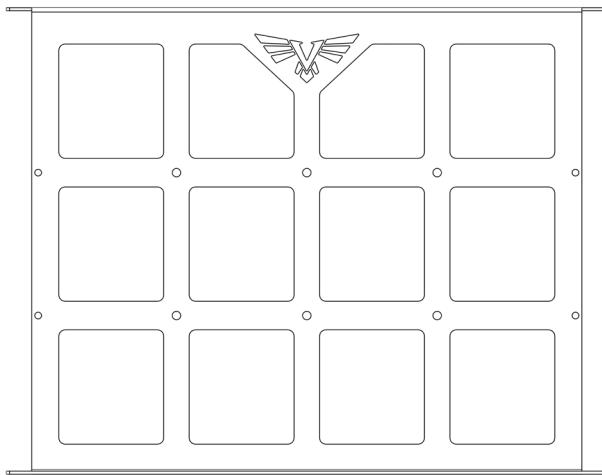

INSTALLATION

1. Start by connecting the provided bracket to the molle panel, as shown and oriented below. Using (2) of the provided 1/4"-20 button heads and flange nuts to secure. Repeat this process for the other side.

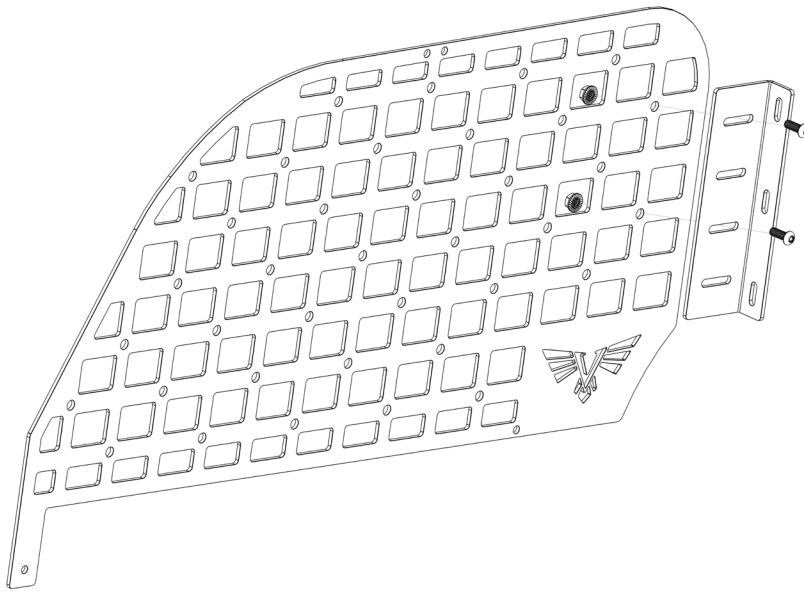

2. Next, assemble your (3) provided panel pieces together, as shown and oriented below. You will need to use (12) provided 1/4"-20 button heads and flange nuts to secure.

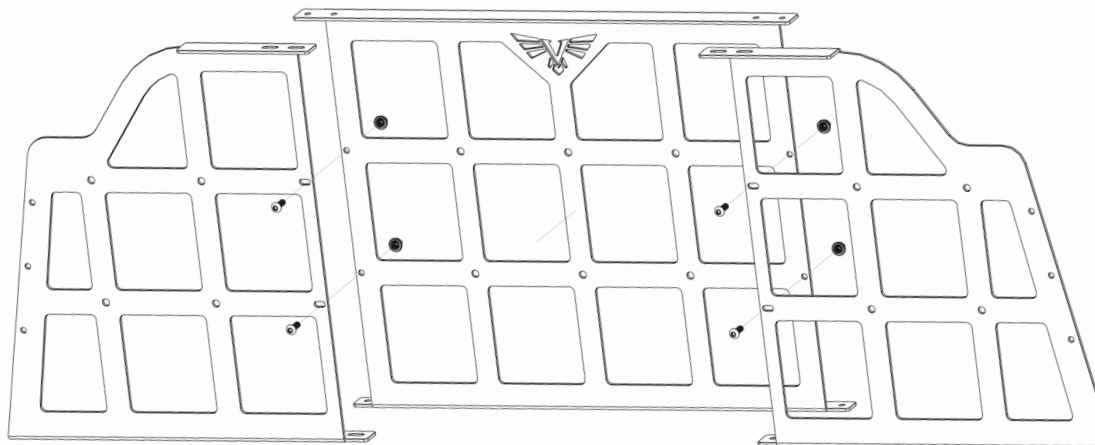

INSTALLATION

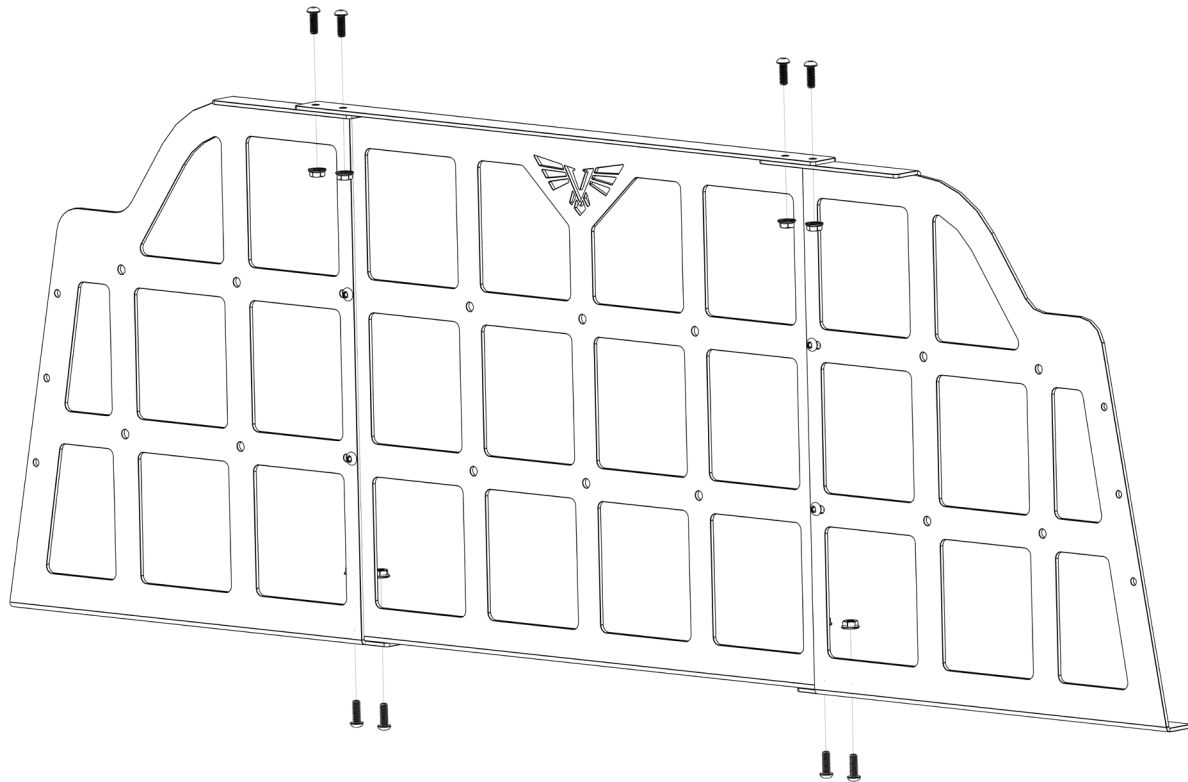

- 3.** Once your (3) panel pieces are assembled and hardware tight, secure the pet divider to the brackets on molle panel with (3) provided 1/4"-20 button heads and flange nuts. Secure as shown in the orientation below on each side.

